



SloanLED[®]
Leaders in LED Technology

LED Spa Lighting Solutions

Set yourself apart with LED Innovation, Experience and Selection

Create the Lighting



Control the Experience

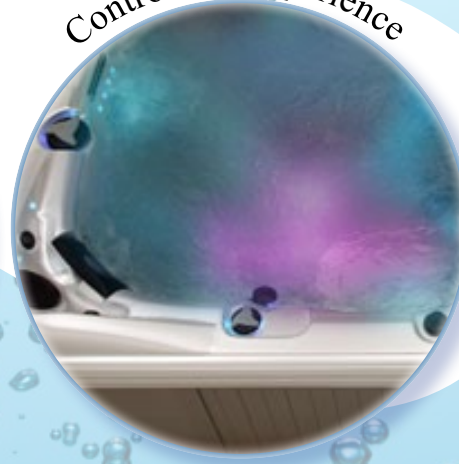

Illuminate the Exterior





50 Years of Lighting Excellence

The SloanLED Company was founded in 1957 to design and develop high-reliability lighting products. By the early 1970s, SloanLED had become a pioneer in Light Emitting Diode (LED) technology. The founder, Charles Sloan, was driven by two simple principles: employ the latest technologies to develop quality lighting products and take really good care of the customers. Today, more than 50 years later, SloanLED continues to deliver on those principles.

The company is a leader in the development and application of LEDs, serving many commercial, industrial and high-tech industries. By combining its over 50 years of lighting experience with ISO 9001 quality recognition, strong warranties, superior technical assistance and unparalleled customer service, SloanLED is dedicated to providing the spa and backyard industry with the best LEDs, the best support and the best results.



LiquaLED Features and Benefits

The LiquaLED line of products are designed for easy installation, easy operation and easy service.

Key features found through out the line include:

- LED technology producing a full spectrum of changing colors and sequencing
- Daisy chain wiring adds flexibility to configurations and ease to installations
- Positive lock overmold connectors allow for quick installs and reliable connections
- High temp cable sets prevent melted cables due to foam curing
- Patent pending overmold connector protect from vibration, moisture, dirt and foaming operations
- LEDs are operated by top-side control of spa pack
- Low voltage and fused to protect from shock hazard and overheating

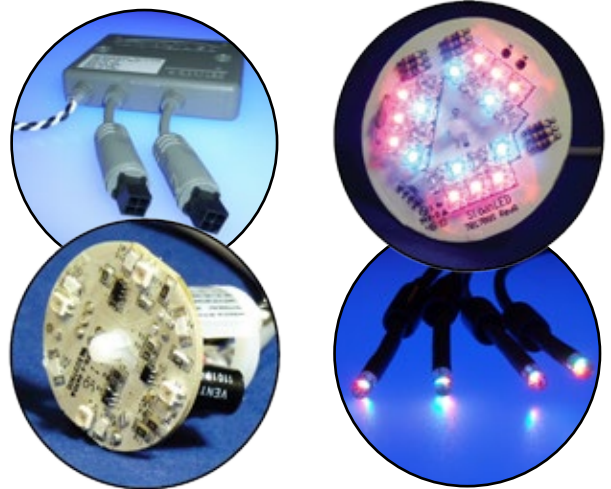

Set Yourself Apart with Customized Lighting and Features

OEM-defined color shows

Independent lighting experience for multiple zones

Dual input power support (spa pack or external supply)

Customize Lighting - colors, patterns and zones

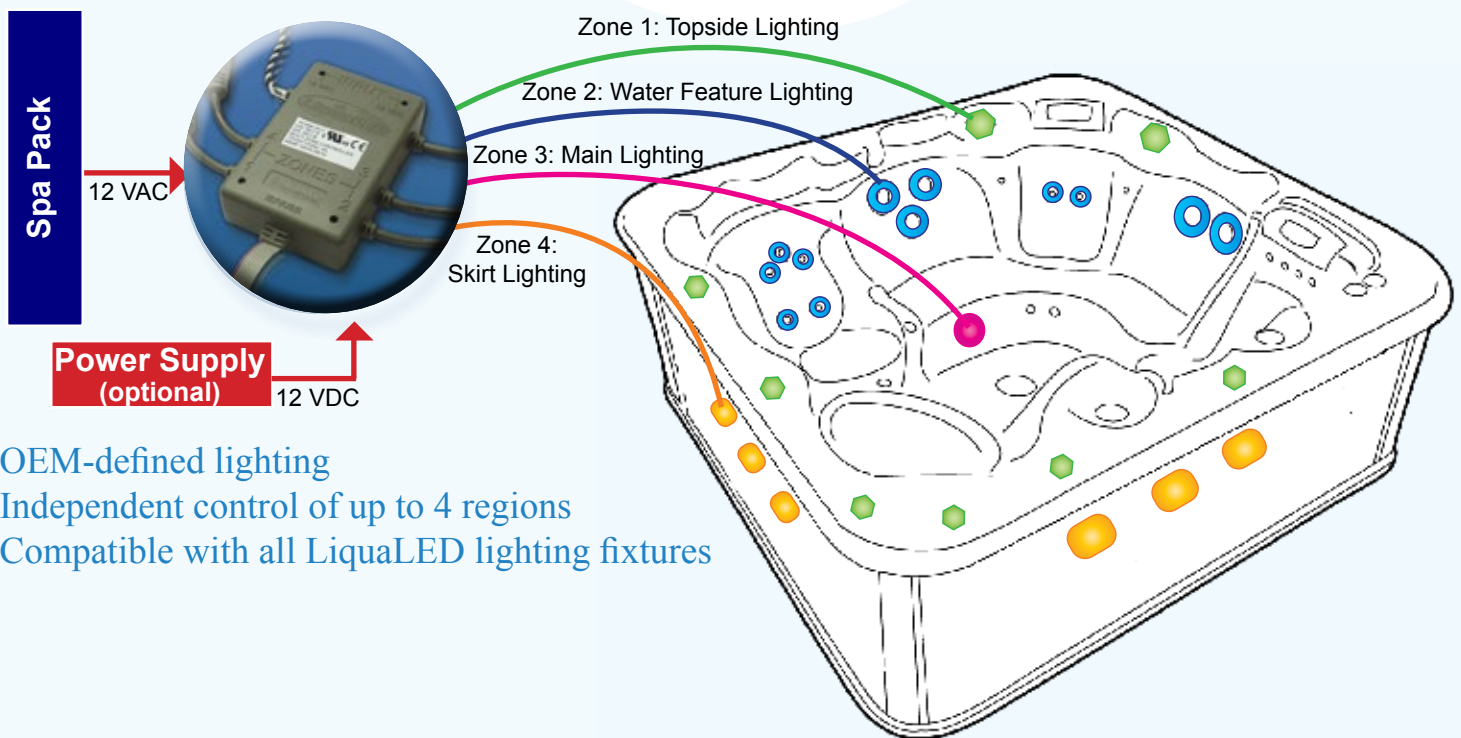

- OEM-defined lighting
- Independent control of up to 4 regions
- Compatible with all LiquaLED lighting fixtures

Bullet Lenses - shapes, textures and clarity/frost



- Wide, low-profile textured/faceted lens
- UV-stable polycarbonate
- Proven reliability
- Easy to install

LiquaLED Multi-Zone Controller

Customize and define color experience for up to four zones



- Independent control of up to 4 regions within spa
- SloanLED-provided default behavior or OEM-defined experience for each zone
- Controls and synchronizes all LEDs
- Controls up to 100 points of light
- Attached lighting can be powered by spa pack or external power supply
- Customized color, brightness, flashing and wheel speed
- Compatible with all LiquaLED Cluster Lights, Bullet Lights and Accent Lights
- Moisture resistant electronics
- Easy to mount anywhere in spa's equipment area
- Patent pending control technology



Bullet Light Lenses

Enhance your brand with bullet lenses

- New Standard lenses
 - frosted / diffuse lens
 - octagonal clear lens
 - wide, low-profile texture lens
- All lenses are:
 - UV stable
 - easily installed
 - proven reliable



Examples of cuts and shapes

For more information contact your Territory Sales Manager or SloanLED Customer Service representative.

How the Systems Work

- All LEDs are controlled by a central Controller box
- Spa pack switch turns LEDs on/off and changes color settings
- Cables daisy-chain together with locking Guardian overmolded connectors
- Cables can either be put together in one long string or split into multiple branches
- Controller is protected by in-line fuse

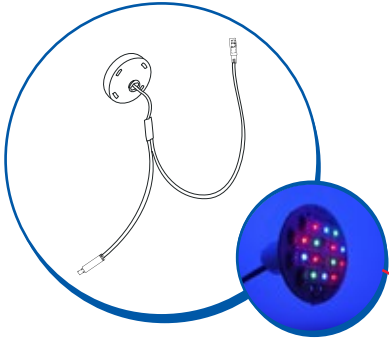

Cluster Main Lights

- Three different sizes available, 21 LED (5" Lens), 14 LED (3.5" Lens), 7 LED (2" Lens)
- Mounts in receptacle that threads to the end of the light fixture
- Stand-alone cluster with on-board controller also available (UltraBRITE light P/N 701739-SAO) or mini Ultra Brite P/N 701861-9-P)

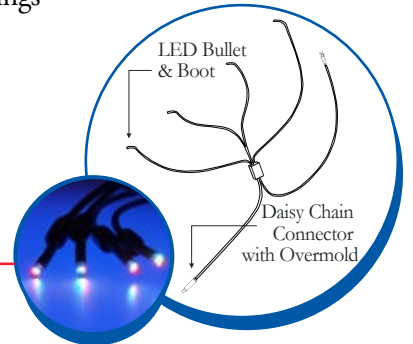

Bullet Lights and Lenses

- Cable branches into either 4 LEDs (Quad), 2 LEDs (Dual), or 1 LED (Single)
- LED boot secures and protects light
- Standard or Customize Bullet Light Lenses

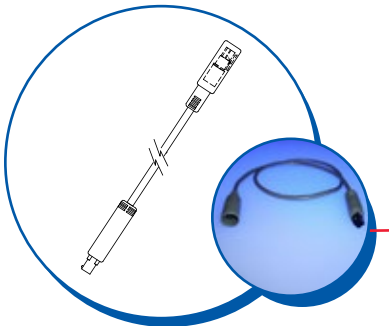

Jumper Cables

- Used for extended connection between lights
- Comes in 2' or 5' lengths
- Female connector protected by an overmold

Available Accessories

- Perimeter lights — standard and premium
- Skirt lights
- Bullet lenses
- 12 VCD External power supplies
60 Watt and 20 Watt

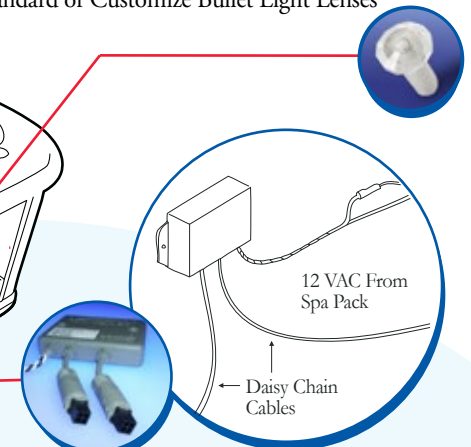
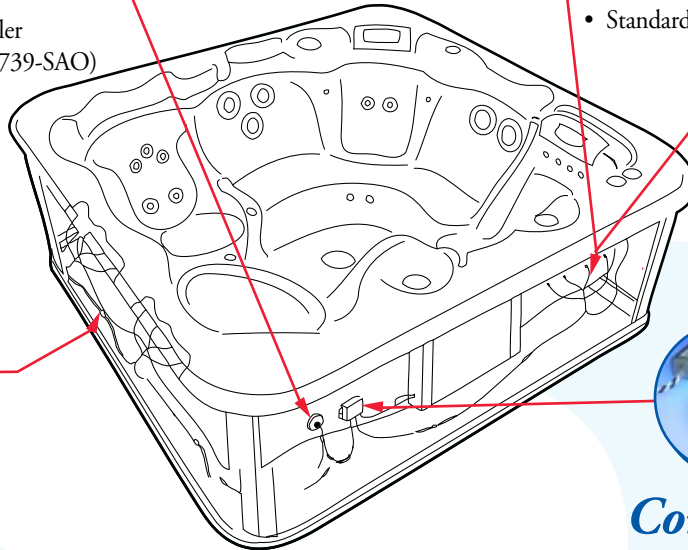

Controller

- Customize and define color with the Multi-Zone Controller
- Or choose a pre-programmed controller such as our Control 40 (701678-DLO) or UltraBRITE (701739-SAO)

LiquaLED Offers an LED Lighting System for Every Spa

SloanLED's LiquaLED product line offers full-featured, color-changing LED systems for the complete spectrum of today's spas – from the most basic entry-level spa to your most exclusive, premium models.

Centered on LiquaLED's proprietary controllers and software programs, the line offers three distinct systems and price points. Simply select the system that best matches each spa model's LED lighting requirements. LED lighting components include cluster main lights (in three sizes), bullet "spot" lights (in five configurations), perimeter lights and skirt lights. Controller choices include two stand-alone system controllers, and two self-contained LED cluster lights each with its own on-board controller (stand-alone, one expandable).

Use the below system matrix to help determine the best system for any given spa. The product data sheets, in the pages that follow, offer complete product descriptions, features and benefits, and technical specifications. Your SloanLED Territory Manager can assist you in the evaluation, design and prototyping of all your LED systems.

Market Category	Light Colors	LiquaLED Controller	Accepts Bullets and Clusters	Accepts Perimeter Lighting and Skirt Lights	Points of Light (including a main light)	Main Light Included	External 12 VDC Power Required
Premium Spas	4 zone, 7 custom color sequences	Multi-Zone Controller P/N 701898-DLO	Yes	Yes	Up to 100	No	No
Mid-Range, Full Featured Spas	Sequence through 10 color combinations	Control 40, P/N 701678-DLO	Yes	Yes	12-40	No	No
Entry-Level, Value Line Spas	Sequence through 10 color combination	UltraBRITE LED light w/on-board controller and expansion cable, P/N 701739-SAO	Yes	No	1-12	Yes	No
Entry-Level Spas	Sequence through 10 color combination	Mini-UltraBRITE LED light w/on-board controller (bi-pins for connection to socket), P/N 701861-9-P	No	No	NA	Yes	No

UltraBRITE Integrated Controller LED Cluster Lamp

Bring high-end features and quality to entry level spas

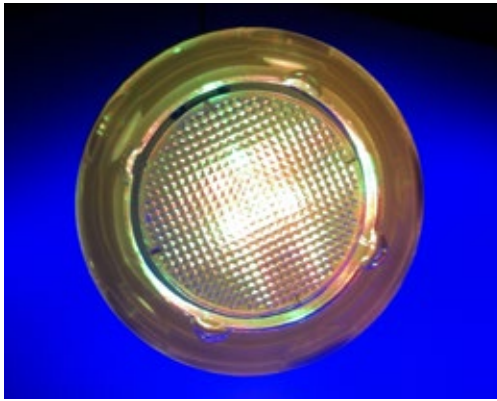

Shorter standoff



Bayonet Mount in
Lens Base

- Fully Integrated Solution
- Ultra Bright LEDs – 50% brighter than traditional LEDs
- New wider viewing angle and shorter standoff – fully compatible with smaller cluster lenses AND provides more uniform illumination of larger cluster lenses
- Lamp includes fully-integrated controller that can display single colors, smooth color transitions, color transition sequences, and strobe effects
- Bayonet-Style Mounting – Installs into standard lens bases, fitting lenses from 2” to 5” in diameter
- Expandability – Integrated expansion cable allows the addition of LiquaLED Bullet Lights or Cluster Main Lights (see chart below) and provides for full synchronization between all lights
- Includes adapter cable, allowing connection via either 2-prong MLX plug or ¼-inch quick-connect terminals
- Reliable – Moisture-resistant electronic coatings
- Over-mold connectors (Guardian Series)

Item Description	UltraBRITE LED Light
Part Number	701739-SAO
High-brightness LEDs per cluster	10 (equal to 16 standard LEDs)
Input voltage	12 VAC
Typical maximum current	240 mA
Diameter of PCB	1.57”
Fits lens sizes (approximate)	~ 2.0” to 5.0”
Lamp depth (front to back)	1.44”

Part Number	LiqaLED Expansion Items	Maximum Current Each	Maximum # of Units*
701570-21-DLSO	21-LED cluster	240 mA	1 Cluster
701570-14-DLSO	14-LED cluster	160 mA	1 Cluster
701570-7-DLSO-S	7-LED cluster	80 mA	3 Clusters
701564-4-DLO	Quad-LED bullet	80 mA	3 Cable sets
701564-2-DLO	Dual-LED bullet	40 mA	6 Cable sets
701564-1-DLO	Single-LED bullet	50 mA	4 Cable sets
701787	Skirt Light	60 mA	4 Lights

*Or any combination of clusters, bullets and accent lights, not to exceed a total of 240 mA (maximum 12 points of light)



UltraBRITE-Mini Cluster Lamp

Bring high-end features and quality to entry-level spas

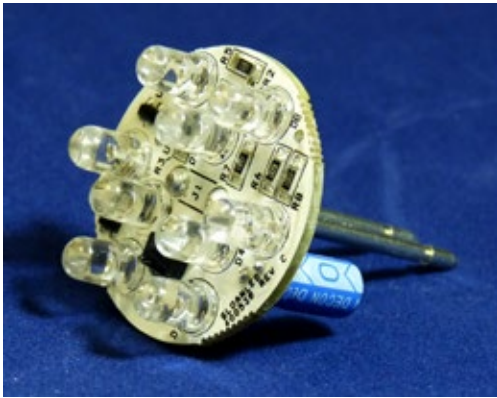

- Fully Integrated Solution – No separate controller required
- High-brightness LED cluster
- Reliable moisture-resistant electronic coatings
- On-board selectable color-controller
 - Color Wheel
 - White
 - Cyan
 - Magenta
 - Blue
 - Yellow
 - Green
 - Red
 - White Strobe



Bi-Pin Connector Style



UltraBRITE-Mini
with lens

- Bi-Pin (-P) used for simple incandescent replacement / retrofitting into standard bulb socket

Part Number	701861-9-P (bi-pin)
High-brightness LEDs per cluster	9 - 5 mm LEDs
Input Voltage	12 VAC
Typical maximum current	200 mA
Diameter of PCB	1.3"
Fits lens sizes (approximate)	~ 2.0" to 5.0"
Fixture depth	1.75"



LiquaLED Multi-Zone Controller

Customize and define color experience for up to four zones



- Independent control of up to 4 regions (zones) within spa
- SloanLED - provided default behavior or OEM-defined experience for each zone
- Controls and synchronizes all LEDs
- Controls up to 100 LEDs
- Controlled by spa pack
- Attached lighting can be powered by spa pack or optional external power supply
- Customized color, brightness, jump speed, wheel speed
- Compatible with all LiquaLED Cluster Lights, Bullet Lights and Accent Lights
- Moisture resistant electronics
- Easy to mount anywhere in spa's equipment area
- Patent Pending control technology
- UL Approved - File Number #E242370

Part number	701898-DLO
Max points of lights	>100
Input voltage from spa pack	12 VAC
Additional lighting power source	Optional 12 VDC input (5A Max)
Number of individual color "shows"	up to 7 (programmable)
Lighting Zones	Up to four
Dimensions	2.9" W x 4.375" H x 1.0" D



LiquaLED Controller Control 40

Controls colors, color-changing and sequencing via built-in software program



- Patent Pending control technology
- Compatible with all LiquaLED Cluster Lights, Bullet Lights and Accent Lights
- UL Approved - File Number #E242370
- Serviceable fused input for safety
- Moisture resistant electronics
- Easy to mount anywhere in spa's equipment area Full Spectrum Color Control
- Controls up to 40 points of light plus one cluster
- Controlled by spa pack
- No external power supply required
- Cost effective control device

Part number	701678-DLO
Max points of lights (not including clusters)	40
Required input voltage – AC	12 VAC from Spa Pack
Required input voltage – DC	No External DC Supply Required
Typical max output current / power	1 Amp / 12 Watts
Controller dimensions	3.25" x 2.75" x .75"
On/Off control	Spa pack light on/off switch on top-side control panel



Bullet Lights

Bullet-shaped color changing LED modules for individual points of light, water features, pillows and other illuminated accessories



Color Changing LEDs

Installation

- LiquaLED Bullet Lights - New, patent pending “bullet” design LED modules with rugged LED-to-cable connection
- Color Changing LEDs – Latest LED technology produces the full spectrum of colors and allows for color changing and sequencing
- Daisy-Chain Wiring - Flexible configurations and easy installation
- Positive Lock Connectors - Quick installs; reliable, industrial strength connections
- Guardian Overmold Connector System - Protects from moisture, dirt, foaming operations
- High Temp Cable Sets - Proven not to melt under the highest temperature foaming operations
- Patent Pending LED Boot - Vibration proof attachment; no adhesives required
- Efficient Electrical Design - Drives more lights from the same power pack
- Integrated Circuitry Protection - Over-molded, water resistant case protects circuitry for reliable, no-fuss operation
- Accessory Lens – several styles available with custom inside diameter taper to fit bullet lights

LiquaLED Bullet Lights and Cable Sets

Item Description	Single-LED Cable	Dual-LED Cable	Quad-LED Cable	Extended Length Quad – LED Cable Connector & Bullet Wire	Extended Length Quad – LED Cable Connector Wire
Part Number	701564-1-DLO	701564-2-DLO	701564-4-DLO	701564-4-DLO-XL	701564-4-DLO-38
# LED's per cable (individual points of light)	1	2	4	4	4
Typical maximum current per cable	50 mA	40 mA	80 mA	80 mA	80 mA
Connector wire length (connector-to-connector)	50"	50"	50"	76"	76"
Outer bullet light wire length	25"	25"	25"	38"	25"
Inner bullet light wire length	25"	25"	17"	24"	17"



Cluster Main Lights

Ultra-bright color-changing LED clusters for vivid, trouble-free lighting



21-LED Cluster



7-LED Cluster



14-LED Cluster

LiquaLED Cluster in
Lens Fixture

Fits Various Lens Sizes

- LiquaLED Cluster - High power LED clusters for main or other large light applications
- Color Changing LEDs – Latest LED technology produces the full spectrum of colors and allows for color changing and sequencing
- Can be integrated with LiquaLED Bullet lights and Accent lights
- Daisy Chain Wiring - Flexible configurations and easy installation
- Ultra Bright LEDs - Over 30% brighter than traditional LEDs
- Positive Lock Connectors - Quick installs; reliable, industrial strength connections
- Guardian Connector Overmold - Protects from moisture, dirt, foaming operations
- High Temp Cable - Proven not to melt under the highest temperature foaming operations

LiquaLED Cluster Main Lights with stand-offs

	21-LED Cluster	14-LED Cluster	7-LED Cluster
Part Number	701570-21-DLSO	701570-14-DLSO	701570-7-DLSO-S
LEDs per cluster	21	14	7
Typical max current	240 mA	160 mA	80 mA
Diameter of PCB	2.9"	2.0"	1.3"
Fits lens size (approximate)	~ 5.0"	3.0" – 5.0"	2.0" – 5.0"
Cable length (connector-to-connector)	36"	36"	36"



Skirt and Perimeter Accent Lights

Add dynamic, full-spectrum, colored LED accent lighting to your spa's exterior

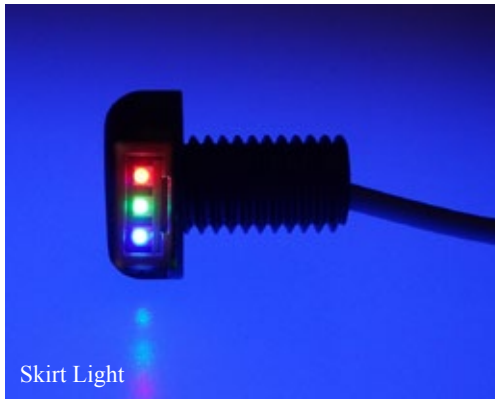

Skirt Light Lighting System

- Color changing modules use Red, Green and Blue LEDs to produce the full spectrum of colors
- Durable housing with integrated threaded shaft mounts to skirting through 5/8" hole and is secured with supplied nylon nut
- Low profile design eliminates damage during crating, shipping and use



Perimeter Lighting System

- This system uses two high-brightness, integrated RGB LEDs per module for beautifully blended colors, and increased brightness
- Higher light output offers longer throw of light and wider coverage area
- Peel-n-Stick or mechanical mounting of modules (using screws/rivets)
- Available in a 7½' string with four modules spaced on 18" centers



	Perimeter Lighting	Skirt Lighting
Item Description	7 1/2-Foot String	Skirt Light Module
Part Number	701755-M4-18-DLO	701787
# Modules	4 Modules per String	1 each
Typical Maximum Current	280 mA per String	60 mA each
Cable Length (connector-to-connector)	7 1/2' Total Cable	36" Cable

Accessories

SloanLED 12 Volt Power Supply



Modular 60



Self-Contained 20

- All SloanLED Power Supplies are rated for Damp Location specification
- Perfect addition when requiring more than 1 amp current on the Multi-Zone Controller, P/N 701898-DLO
- No fuses to replace or circuit breaker to reset. Short Circuit Protection automatically resets when short condition is no longer present
- Simple primary hook-ups and 12 Volt DC Class 2 outputs
- Simple secondary hookups - no minimum load, no load balancing and no dip switches
- Proven reliability, rugged housings
- Limited warranty of up to 5 years

Item Description	LED Power Supplies	
	Self-Contained 20	Modular 60
Part Number	701680	701507-MODW
Nominal Input Volts	120/240 Volts	120/240 Volts
Input Current	.3 Amps	1.0 Amps
Output Voltage	12 VDC	12 VDC
Output Current	1.67 Amps	5 Amps
Power Output	20 Watts	60 Watts
Overall Dimensions	3.75" L x 1.6" W x 1" H	9" L x 2.5" W x 2" H

Jumper Cables



- Can be used anywhere in the LiquaLED system, including between Cluster Lights, Bullet Lights and Perimeter Lights
- Two lengths (2' and 5') are available
- Both versions contain the same Guardian Overmold Connector System found in our other LiquaLED products

Part Number	Length
410117-24-0	2'
410117-60-0	5'

Accessories

Bullet Light Lenses

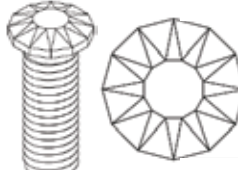

- Easy to install
- Four styles to choose from
- Proven reliability, rugged molded acrylic

Features	Standard Lens	Wide Flange Lens	Wide Flange Faceted Lens	Large Round Lens (1" diameter)
Style				
Flange Diameter	0.530"	0.600"	0.580"	1"
Mounting Method	Nut on threaded and/or press fit using ribs on shaft			
Drill Size	W Drill (0.386")			
Length (bottom of flange to end of threads)	1.127"	1.127"	1.127"	1.127"
Length of Non-threaded ribbed section (below flange)	0.284"	0.125"	0.125"	0.125"
	Part Numbers			
Lens	400372	400372-W	400372-WF	400372-RND
Nut	400388	400388	400388	400388
Standard (0.070" O-Ring only)	400417	400417	400417	N/A
Thicker (0.103" O-Ring only)	N/A	400510	400510	N/A

Accessories

Miscellaneous Accessories

Part Number	Description
400354	1.6 Amp, 250 V Fuse (for use with 701678-DLO Control 40)
701819	120VAC to 12VAC, 1 amp Wall Mount Power Supply (for trade shows or demo use)
701786	LiquaLED Tester
400524	LiquaLED Tester Instructions

Spa Sample Request Form

Company: _____
 Contact: _____
 Address: _____

 Phone: _____ Fax: _____
 E-Mail: _____
 Spa Model: _____ Spa Size: _____
 1. Expected Annual Production: _____
 2. Production Start Date? _____
 3. Requested Sample Ship Date? _____
 4. Shipping Instructions/Comments: _____
 5. Requested by: _____ Date: _____

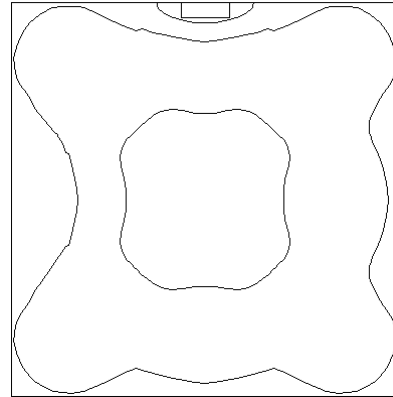

Description	Part Number	Qty
Bullet Lights		
Quad-LED Bullet Cable Set with Connector Overmold	701564-4-DLO	
Dual-LED Bullet Cable Set with Connector Overmold	701564-2-DLO	
Single-LED Bullet Cable Set with Connector Overmold	701564-1-DLO	
Quad-LED Bullet Cable Set with Connector Overmold and 38" connector length	701564-4-DLO-38	
Quad-LED Bullet Cable Set with Connector Overmold and Extra Long Bullet Cables	701564-4-DLO-XL	
Bullet Lens, Polycarbonate, UV Stable	400372	
Nut, 3/8-16, Nylon Hex for 400372	400338	
O-Ring	400417	
Bullet Lens, Polycarb, UV Stable, Wide Flange	400372-W	
Bullet Lens, Polycarb, UV Stable, Wide Flange, Faceted	400372-WF	
Thicker O-ring, Silicone, .362 ID x .103 CS, 70D, Clear. For use with bullet lenses	400510	
Cluster Main Lights		
21-LED Cluster with Stand-off w/overmold	701570-21-DLSO	
14-LED Cluster with Stand-off w/overmold	701570-14-DLSO	
7-LED Cluster with Stand-off w/overmold	701570-7-DLSO-S	
Perimeter and Skirt Lights		
6' Premium Perimeter String, 4 modules, 18" on center (High-Brightness Modules with Integrated RGB)	701755-M4-18-DLO	
Skirt Light	701787	

Description	Part Number	Qty
UltraBRITE LED Light		
10-LED UltraBRITE Cluster w/expansion cable	701739-SAO	
9-LED UltraBRITE Mini (bi-pin)	701861-9-P	
Controllers & OverMold Adapter		
Multi-Zone Controller	701898-DLO	
Control 40	701678-DLO	
1/4" QC Terminal Connector Adapter	410119	
Accessories		
Modular 60 Power Supply, 12VDC, 5A, 60W	701507-MODW	
SC 20 Power Supply, 12VDC, 1.67A, 20W	701680	
2' Jumper Cable w/overmold	410117-24-O	
5' Jumper Cable w/overmold	410117-60-O	
Marketing Materials		
LiquaLED Catalog	000701-CAT	
Misc		
Wall Mt. P.S. (12VAC, 1 AMP w/Molex)	701819	
LiquaLED Tester Box, 12VDC/AC	701786	
LiquaLED Tester Box Instructions	400524	
Notes		

Ordering Information

Part Number	Product Description	Min Order Qty	Master Carton Qty	Comments
Bullet Lights				
701564-4-DLO	Quad-LED Bullet	10	100	Includes cabling
701564-4-DLO-XL	Extended Length Quad (connector and bullet wires)	10	100	Includes cabling
701564-4-DLO-38	Extended Length Quad (connector wires only)	10	100	Includes cabling
701564-2-DLO	Dual-LED Bullet	10	100	Includes cabling
701564-1-DLO	Single-LED Bullet	10	100	Includes cabling
400372	Bullet Lens	500	500	Order in 500s, Fits 3/8" hole
400338	Nut, 3/8, Nylon Hex for Fits All Lens style	500	500	Order in multiples of 500
400372-W	Wide Flange Bullet Lens	500	500	Order in multiples of 500
400372-WF	Wide Flange Faceted Bullet Lens	500	500	Order in multiples of 500
400372-RND	Large Round Lens (1" diameter)	500	500	Order in multiples of 500
400417	O-Ring - .364IDX.070 CS	500		Order in multiples of 500
400510	O-Ring - .362IDX.130 CS	500	TBD	Order in multiples of 500
Cluster Main Lights				
701570-21-DLSO	21-LED Cluster	10	100	Fits ~ 5" Lens, Includes 36" cable
701570-14-DLSO	14-LED Cluster	10	100	Fits 3" – 5" Lens, Includes 36" cable
701570-7-DLSO-S	7-LED Cluster	10	100	Fits 2" – 5" Lens, Includes 36" cable
Perimeter and Skirt Lights				
701755-M4-18-DLO	6' Premium Perimeter String	10	50	
701787	Skirt Light	10	TBD	Mounts through 5/8" hole
Controllers				
701898-DLO	Multi-Zone Controller	10	28	Requires external 12 VDC power only when exceeding 1 Amp power from Spa Pack
701678-DLO	Control 40	10	60	Does not require external power
410119	Terminal Connector Adapter	10	1,000	
400354	Fuse, 1.600A, 250V,X20MM, Fast Acting for 701678	100	TBD	
UltraBRITE LED Lights				
701739-SAO	10-LED UltraBRITE Light	10	120	Fits 2"–5" Lens, includes adapter cable
701861-9-P	UltraBRITE Mini 9-LED Light with Bi-Pin	10	120	
Accessories				
701507-MODW	Modular 60 Power Supply	5	20	60 Watts
701680	SC 20 Power Supply			20 Watts
701819	Wall Mount Power Supply (1 amp, 12VDC)			
410117-24-O	2' Jumper Cable	20	400	
410117-60-O	5' Jumper Cable	20	200	
701786	LiquaLED Tester			
400524	LiquaLED Tester Instructions	20	200	



Contact Information

SloanLED Corporate Offices

Toll-Free 888.747.4LED (888.747.4533)

Tel 805.676.3200

Fax 805.676.3206

Email spa@sloanled.com

Website SloanLED.com

Technical Support Hotline: 888.756.2699